

Лекция 13.

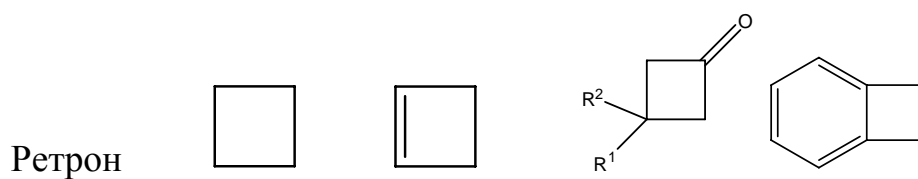

1. Анализ

Трансформ алкилирование.

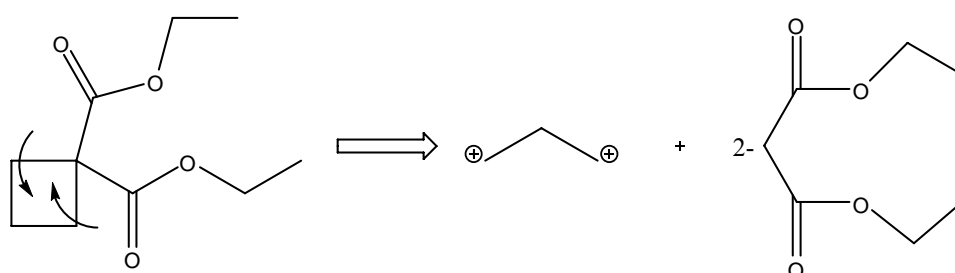

Синтез

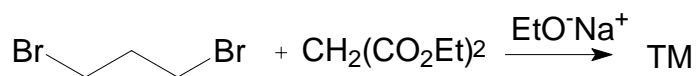

2. Анализ. Трансформ [2+2]-циклоприсоединение

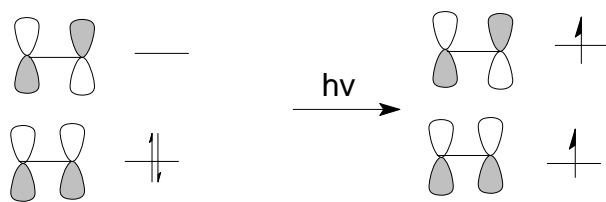
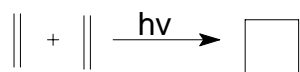

Разрешено по симметрии

Проблема региоселективности

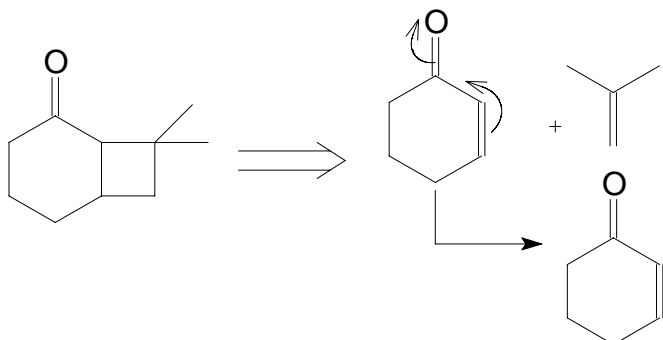

Синтез

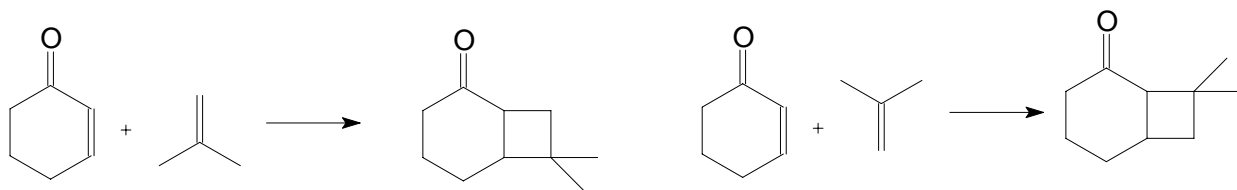

Анализ 2

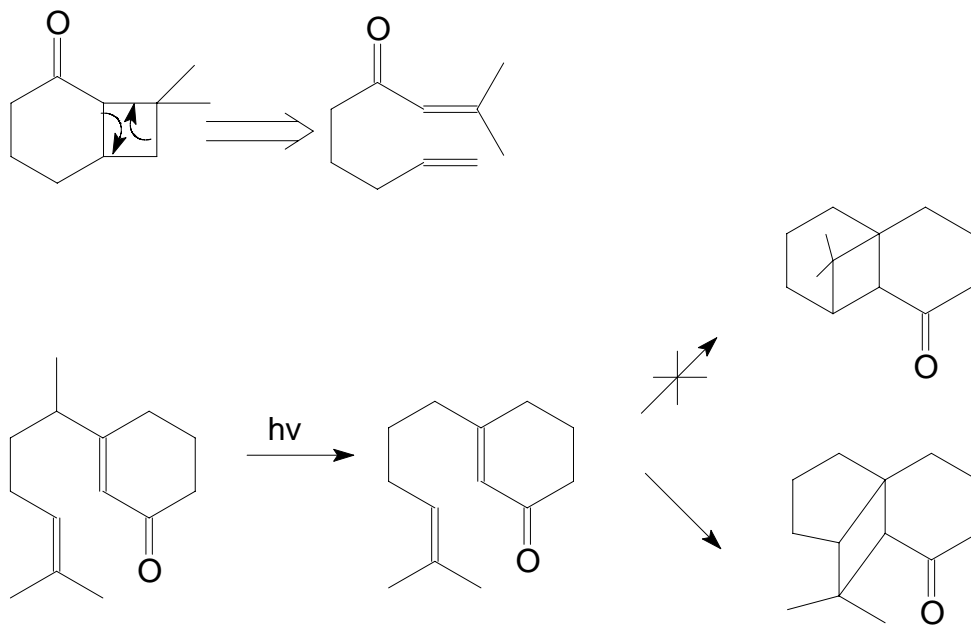

3. Анализ

Трансформ электроциклическая реакция

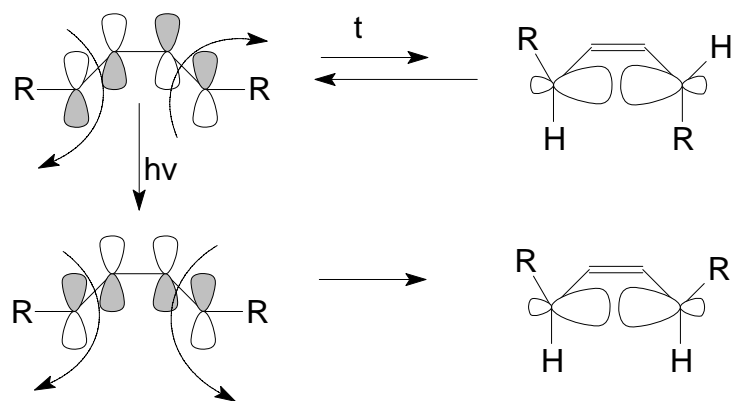

4. Анализ Трансформ Троста

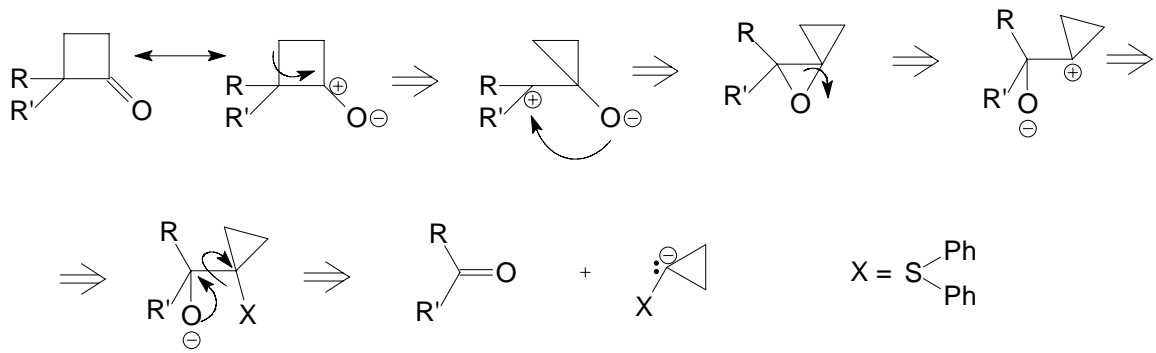

Синтез

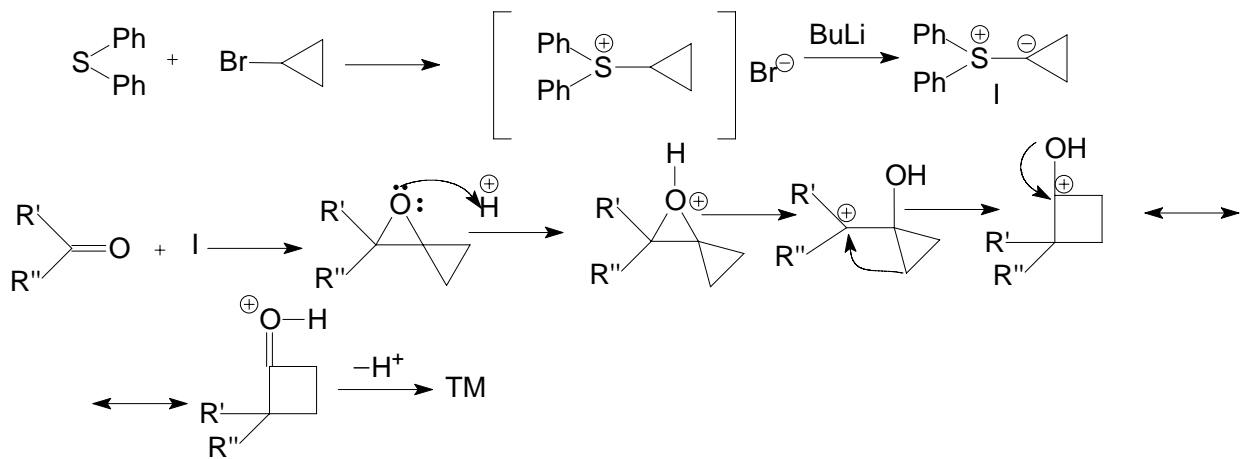

Анализ

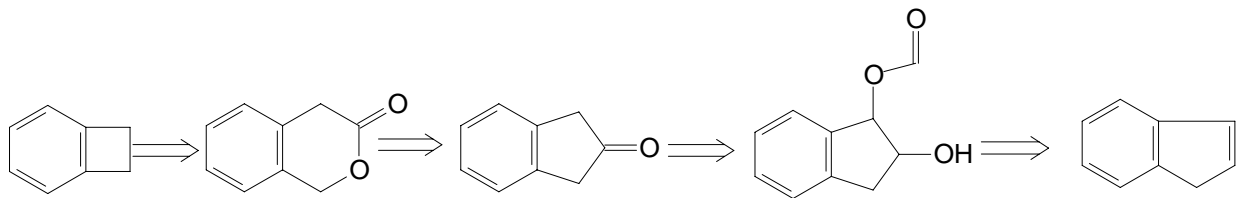

Синтез

